

212 + 213 Wall Concept Modulo

Montagehandleiding
Guide d'installation
Installation instructions

AC
AQUA CONCEPT®

Schaarbeekstraat 34
9120 Melsele
Belgium
t. 00 32 3 296 03 03
info@aquaconcept.eu
www.aquaconcept.eu

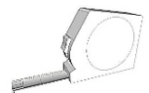
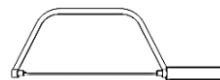
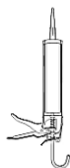
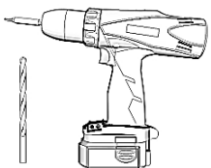

Vorbereitung

Lees na het openen van de dozen eerst deze introductie zorgvuldig!!!!

Kijk alle verpakte onderdelen goed na op transportschade en check aan de hand van het "overzicht onderdelen" of alle onderdelen geleverd zijn. Als een onderdeel ontbreekt, beschadigd is of een slechte afwerking heeft, neem dan onmiddellijk contact op met uw plaatselijke distributeur.

Alle vereiste sanitair en afvoer moet geïnstalleerd zijn voordat u de douche plaatst.

Kijk vóór de installatie na of de vloer en de muren waterpas en stevig staan en ze het totale gewicht van de opstelling en de gebruiker kunnen ondersteunen. Onregelmatige vloer of een onjuiste hoek van de zijwanden zal resulteren in ernstige problemen voor uw installatie. Let op dat er een aantal aanpassingen en boringen noodzakelijk zouden kunnen zijn tijdens de montage !!

De bijgeleverde pluggen zijn niet van toepassing voor alle muurtypes. Gelieve steeds aangepaste pluggen te gebruiken!!

Product onderhoud.

1. Gehard glas kan gereinigd worden met niet-schurende reinigingsmiddelen voor de badkamer of een glasreiniger die u elders in uw huis zou gebruiken. Indien er glasreiniger werd gebruikt op aluminium onderdelen, spoel deze zo snel mogelijk af! Dit om schade aan het geanodiseerd oppervlak te voorkomen. Vermijd slaan op het glas met scherpe of harde voorwerpen. Dergelijke beschadigingen kunnen onmiddellijke of latere breuk van het geharde glas veroorzaken.

2. Het aluminium in uw douche deur is duurzaam en bestand tegen waterschade. Het is raadzaam, maar niet noodzakelijk om te drogen met een handdoek na het douchen. Reinig het zo vaak als nodig is, om de ophoping van vuil, watervlekken of zeepvlekken te vermijden. Gebruik nooit schuurspunzen of andere grove materialen op het aluminium. Gebruik alleen een zachte, vochtige doek en niet-schurende reinigingsmiddelen voor de badkamer.

Preparation

After opening the boxes, start by reading this introduction thoroughly!

Please check all the separate packaged components for transportation damage and use the 'synopsis of parts' to check if all the parts have been delivered. If any part is missing, damaged or has a poor finishing, please contact your supplier immediately. All the required plumbing and drainage has to be installed before you install the shower glass. Before you start installing the shower glass, please check if the flooring and walls are levelled and firm and check if they can support the total weight of the shower glass and its user. Irregular flooring or walls that aren't levelled can result in serious problems for your installation. Please keep in mind that several adjustments and drilling can be necessary during the installation. The included plugs aren't applicable for all types of wall. Always use custom plugs, adapted to your type of wall.

Product maintenance

1. Safety glass can be cleaned using non-abrasive cleaning products for your bathroom or a standard glass cleaner you would use elsewhere in your house. If the glass cleaner was used on an aluminum surface, rinse as quick as possible. This is to prevent damage to the anodized surface. Avoid beating on the glass with sharp or hard objects. Damages like that can cause an immediate fracture of the glass or the glass can explode later.

1. The aluminum used for your shower door is durable and resistant to water damage. It is advisable, but not necessary, to dry everything with a towel after using the shower. Clean it as many times as necessary, this to avoid the accumulation of dirt, water stains or soap stains. Never use harsh materials, such as abrasive sponges, on the aluminum. Use only a soft, damp cloth and non-abrasive cleaning products for the bathroom.

Préparation

Après avoir ouvert les boîtes d'emballage, commencez par lire attentivement l'introduction qui suit.

Jetez ensuite un coup d'œil sur l'ensemble des pièces et matériels que vous découvrez. Vérifiez bien si certains dégâts sont apparus dans le transport de marchandises. Si une pièce est endommagée ou si une mauvaise finition est apparue, veuillez immédiatement contacter votre distributeur local.

Par ailleurs, toutes les plomberies requises et l'évacuation doivent être installées avant toute utilisation de la douche.

Egalement, veillez à bien contrôler avant toute installation, si le plancher et les murs sont fermement fixés à niveau, et ce afin de sécuriser au mieux le poids du futur utilisateur. Un plancher irrégulier ou un angle incorrect des parois latérales se traduira malheureusement par des problèmes graves dans le futur. Enfin, notez bien que des réglages et opérations de forage pourraient s'avérer nécessaires au cours du montage.

Les chevilles ne sont pas applicable à tous les types de murs. S'il vous plaît toujours utiliser des chevilles sur mesures!!!

Produits d'entretien

1. Le verre durci peut être nettoyé avec des détergents, nettoyeurs pour vitres ou autres produits non nocifs pour la salle de bains, produits que vous utilisez régulièrement dans la maison. Il est conseillé de bien rincer les surfaces après avoir utilisé ce type de produits, et ce afin de n'endommager ni l'aluminium ni les surfaces visées. Par ailleurs, évitez de cogner la vitre avec des objets pointus ou durs. Car, cette action pourrait provoquer instantanément - voire plus tard - le bris du verre trempé.

2. L'aluminium fixé dans votre porte de douche est prévu d'une part pour résister au temps, d'autre part pour parer à tout dommage en matière d'humidité. Il est recommandé, mais non nécessaire de sécher l'ensemble de la surface à l'aide d'un essuie-mains après avoir pris une douche. Nettoyez-la aussi souvent que possible, pour éviter l'accumulation de saletés, de taches d'eau ou de savon. N'utilisez jamais de tampons à récureur ou autres matériaux grossiers sur l'aluminium. Prenez soin de n'utiliser qu'un chiffon doux et humide et des détergents prescrits pour la salle de bains.

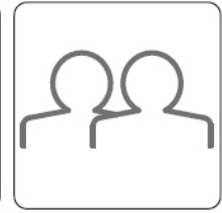
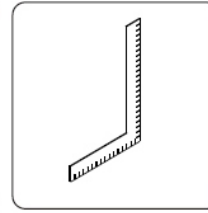
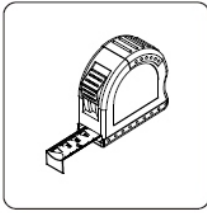
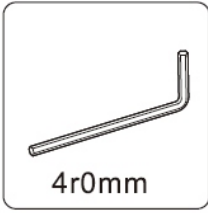
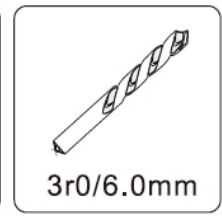
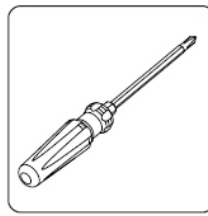
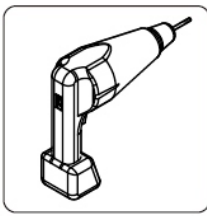
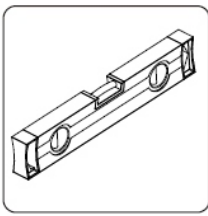
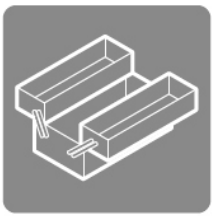

A

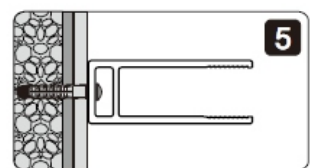
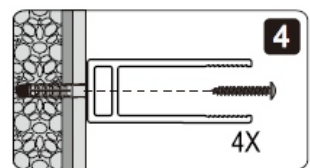
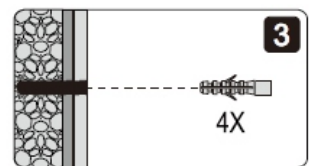
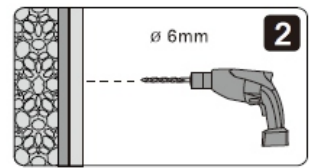
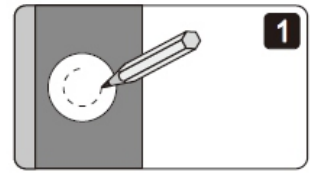
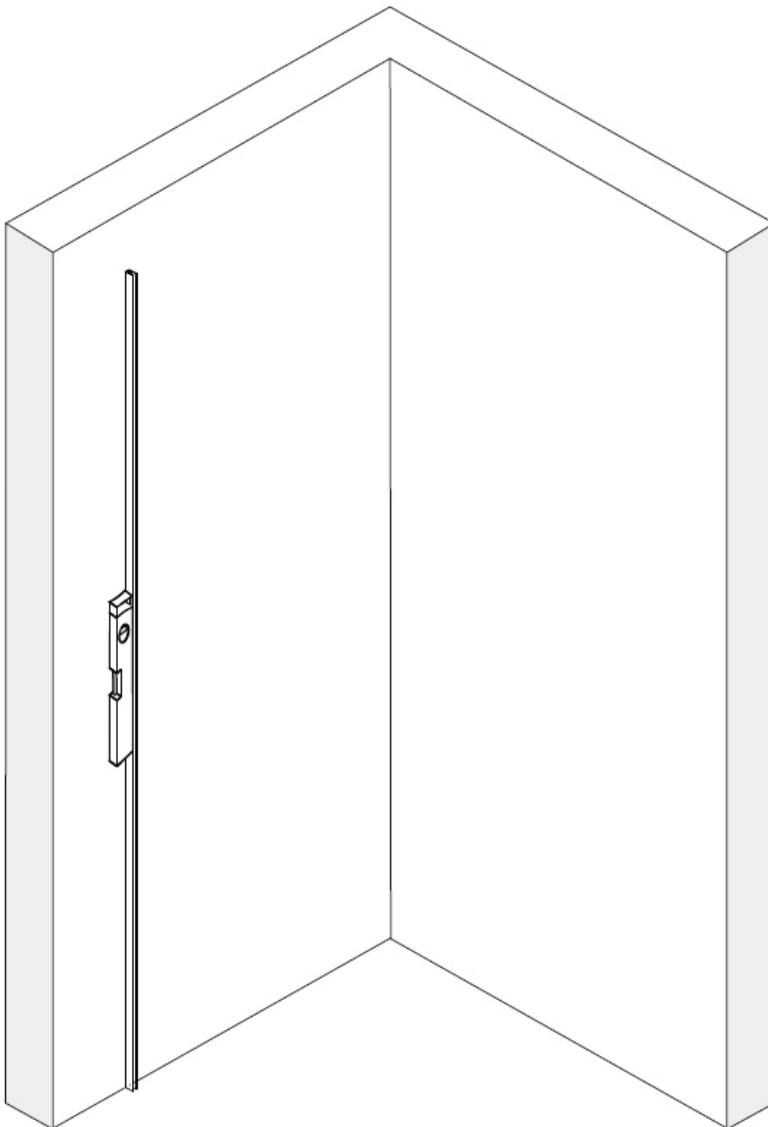

B

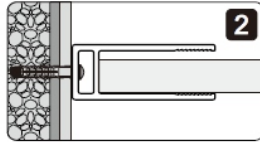
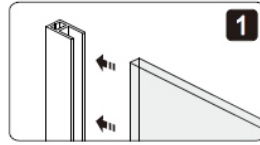
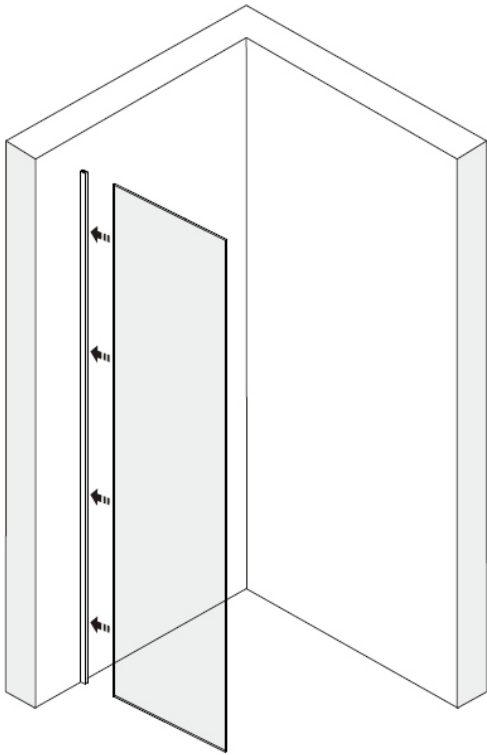

C

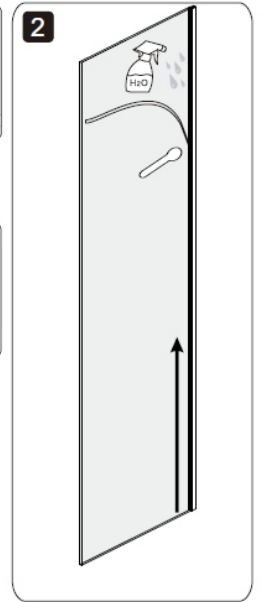
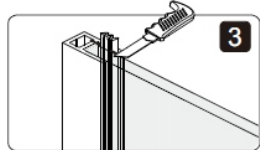
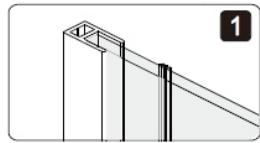
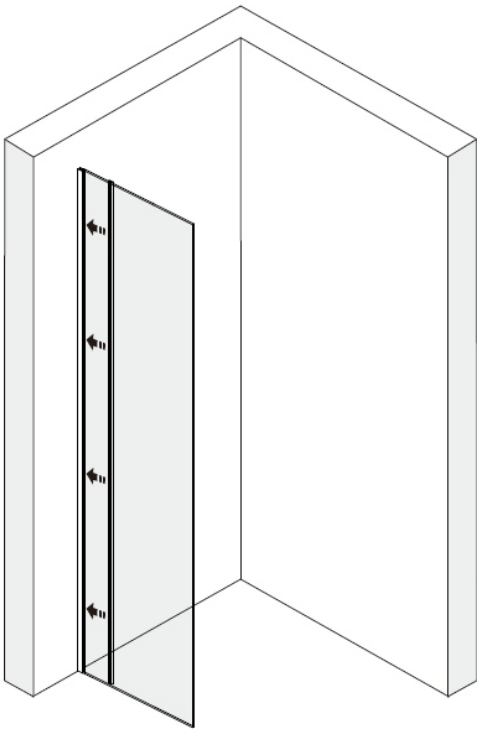

D

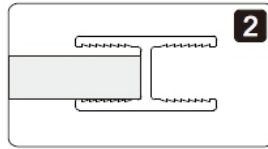
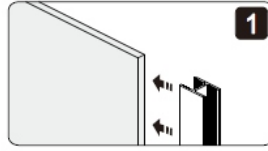
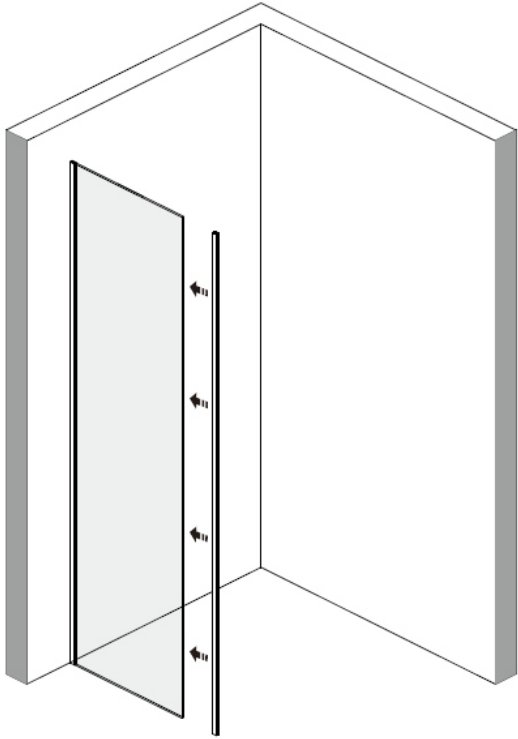

E

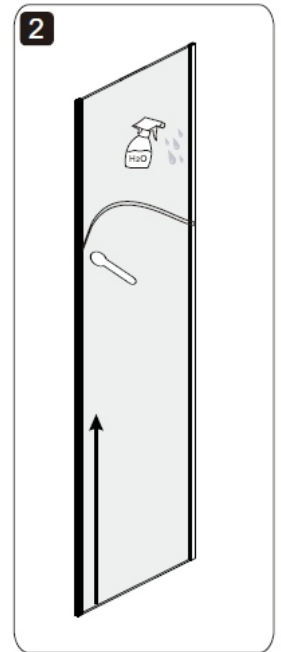
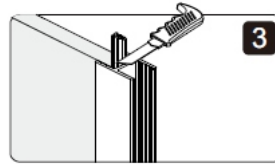
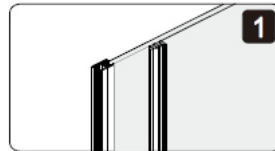
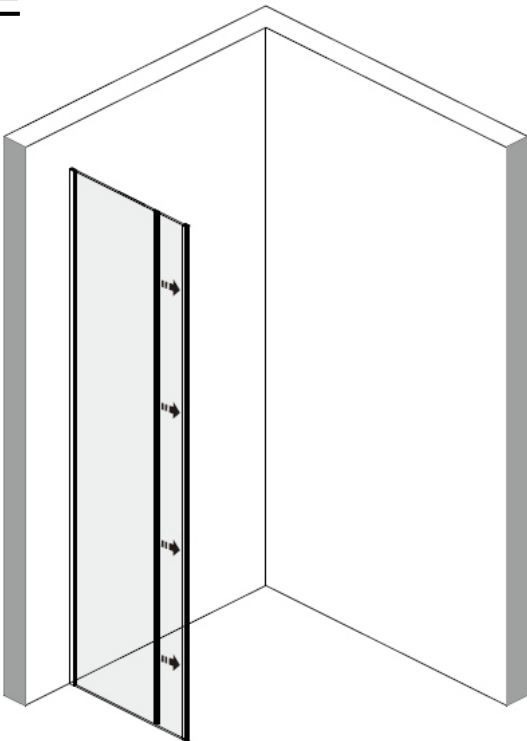

F

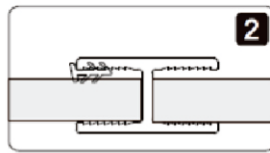
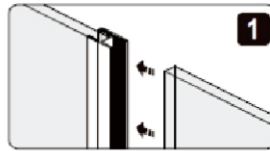
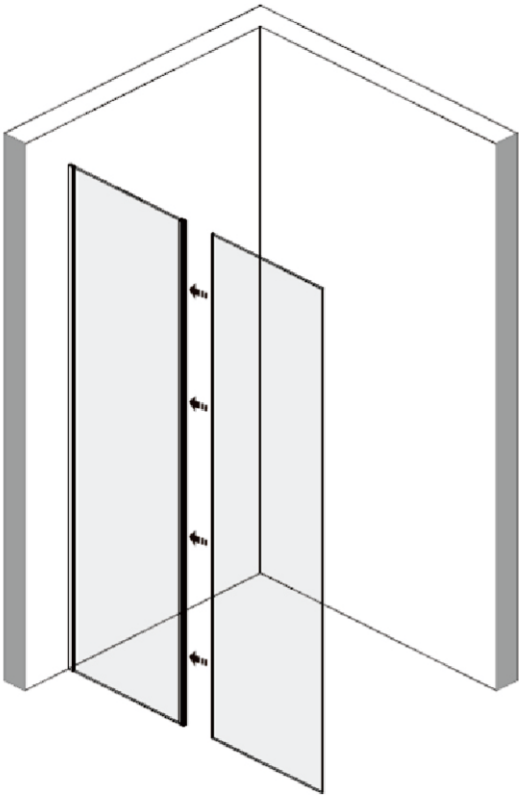

G

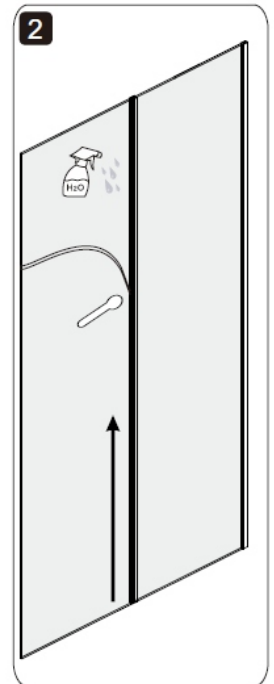
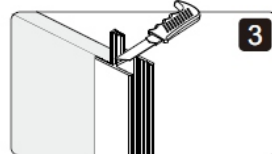
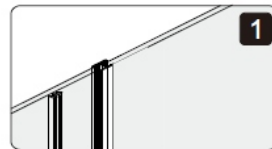
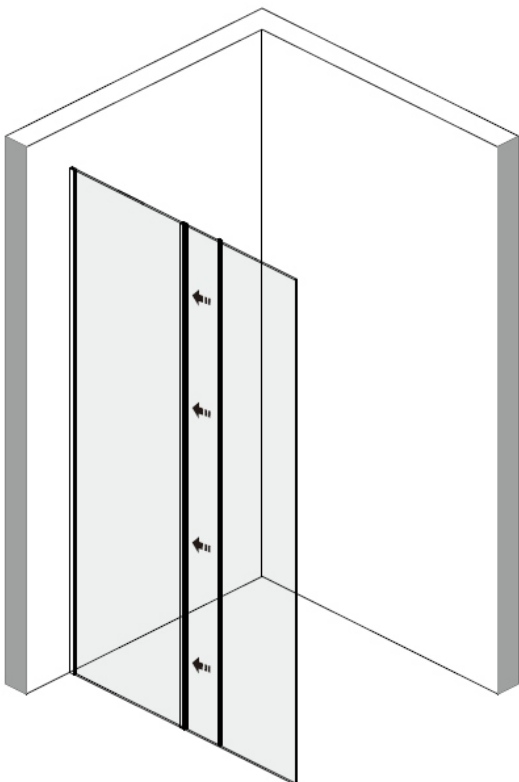

H

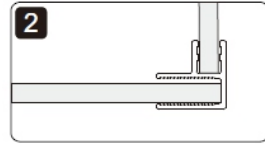
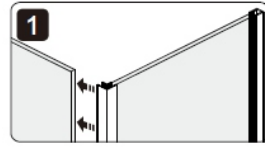

I

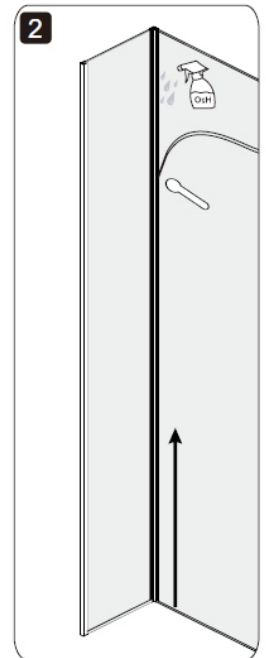
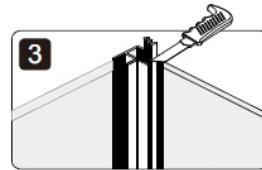
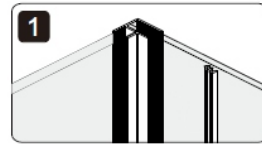
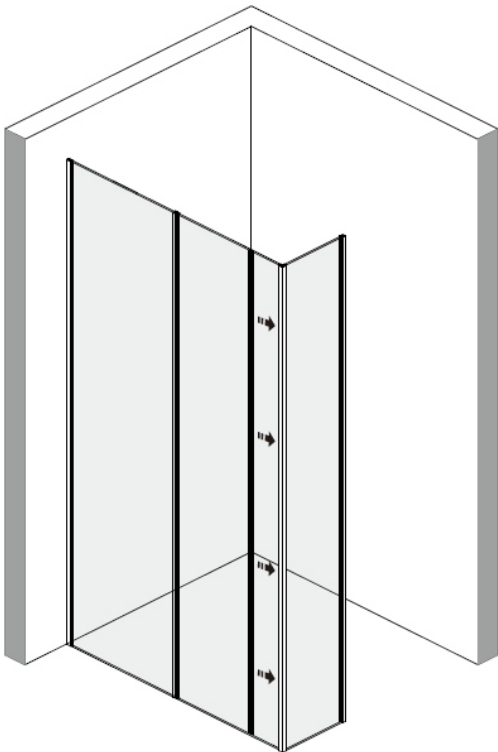

J

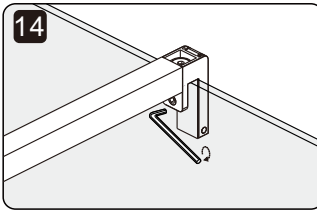
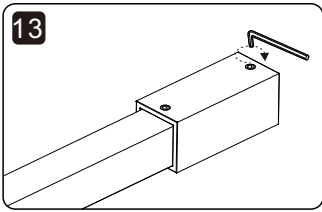
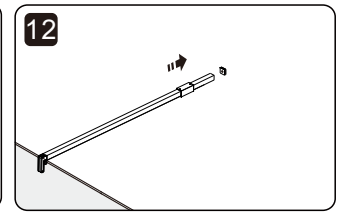
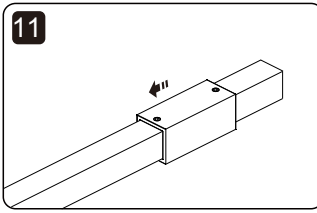
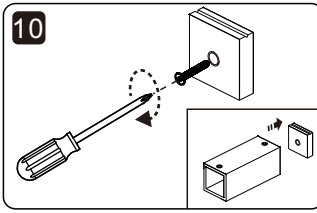
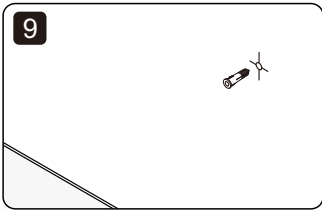
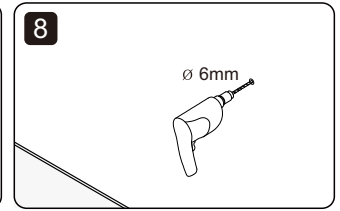
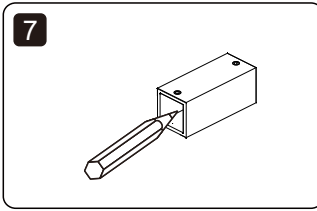
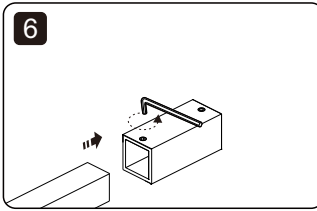
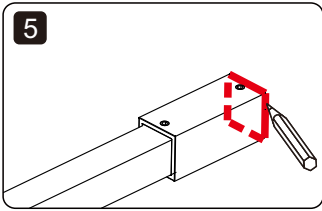
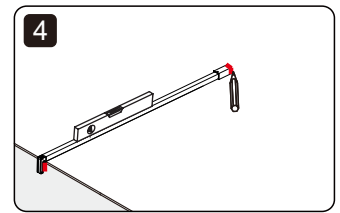
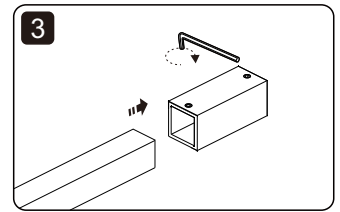
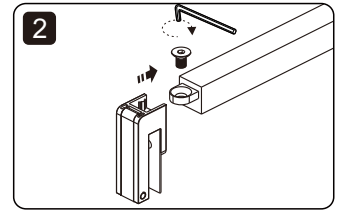
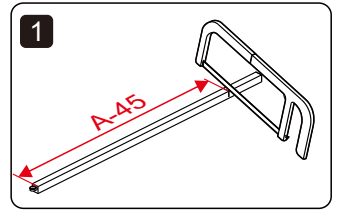
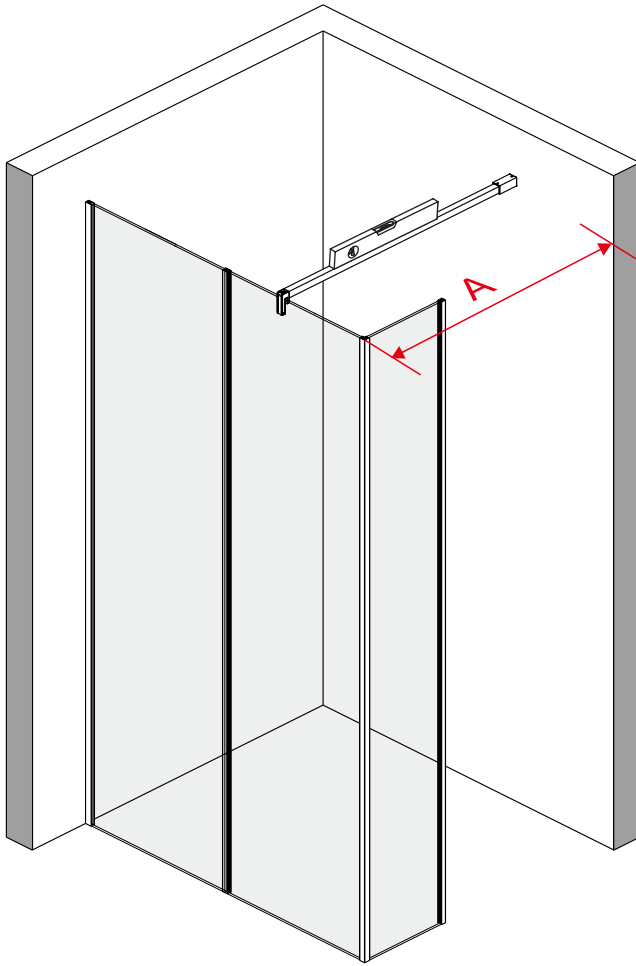

K

